

# Data Sheet



Article number: 0129024

Description: Circlip RB 10 DIN 7993

## Measures

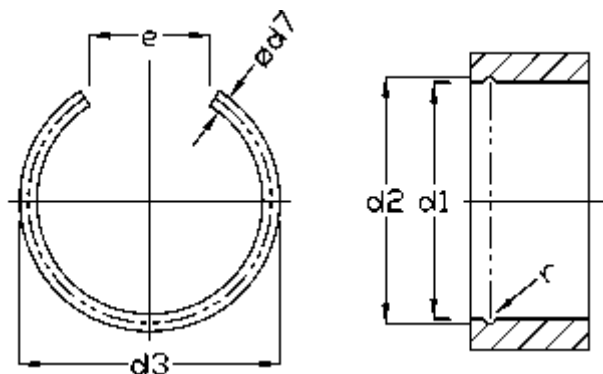

d1	= 10
d2	= 10.80
d3	= 10.9
d7	= 0.8
Description	= RB 10
e	= 4
r	= 0.5
tol	= +0,05 -0,05

tol	= 0.3
Weight kg/1000	= 0.108